



Degasatore
ДЕАЭРАТОР

www.icicaldaie.com

				DATA	04/15	ICICALDAIE	ICI CALDAIE SpA Campagnola di Zevio Verona ITALY	DEG P ICI CALDAIE Spa	QDEG21-1	=				
				DISEGN.	LB									
00	First edition	04/15	LB	VISTO	AP									FG. 1
REV.	MODIFICA	DATA	FIRMA	APPR.	AP	SOST. IL :	SOST. DA :	FILE : QDEG21-1		-	F.S. 2			

Non è permesso consegnare a terzi o riprodurre questo documento né, utilizzare il contenuto o renderlo comunque noto a terzi, senza la nostra autorizzazione esplicita. Ogni inosservanza comporta il risarcimento dei danni subiti. E' fatta riserva di tutti i diritti derivati da brevetti o modelli.

Настоящий документ запрещено передавать третьим лицам или копировать, запрещено использовать содержимое или сообщать его третьим лицам без нашего письменного разрешения. Каждое нарушение влечет за собой возмещение убытков. Все права на патент и зарегистрированный образец защищены.

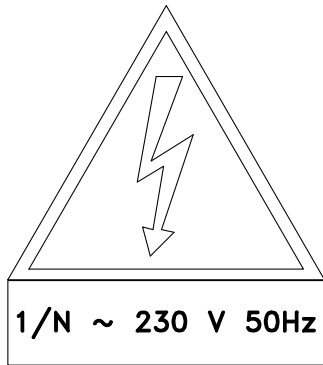

PROGETTO	ICI CALDAIE S.p.A.	РАБОЧЕЕ НАПРЯЖЕНИЕ	1/N~230V 50Hz	НОРМЫ	-	ЗАЩИТА		
SERIE	ДЕАЭРАТОР	КОНТРОЛЬНОЕ НАПРЯЖЕНИЕ	1/N~24V 50Hz	ICI CALDAIE				
ЗАКАЗ	-	СИГНАЛЬНОЕ НАПРЯЖЕНИЕ						
КЛИЕНТ		МАКС-ТОК	2A	ХАРАКТЕРИСТИКИ МЕТАЛЛОКОНСТРУКЦИИ				-
ПОЛУЧАТЕЛЬ		МАКС-МОЩНОСТЬ	0.5KW	МАКС-ТОК				
				ПРИМЕЧАНИЕ				Защищать в соответствии с законами, действующими в стране установки
				НОМЕР ЩИТА УПРАВЛЕНИЯ				-
				ЧЕРТЕЖ	ДАТА	ПОДПИСИ	ДЕАЭРАТОР ICI CALDAIE Spa	
				РАЗРЕШЕН	04/15	LB		
				УТВЕРЖДЕН	04/15	LB		
				QDEG21-1				ЛИСТ 1
00	Первое издание	04/15	LB					T.F. 30
ОСМОТР	ИЗМЕНЕНИЕ	ДАТА	ПОДПИСИ	ЗАМЕН	ЗАМЕН	ФАЙЛ	QDEG21-1	

PROGETTAZIONE	ICI CALDAIE SpA	TENSIONE ESERCIZIO	1/N ~ 230 V 50Hz	NORME	-	PROTEZIONI		
SERIE	Degasatore	TENSIONE COMANDI	1/N~ 24V 50Hz	ICI CALDAIE				
COMMESSA	-	TENSIONE SEGNALI						
COMMITTENTE	-	CORRENTE MASSIMA	2A	CARATTERISTICHE - CARPENTERIA				
DESTINATARIO		POTENZA MASSIMA	0.5KW	CORRENTE Icc - MASSIMA KA				
				NOTE				Proteggere a monte come prescritto da CEI 64/8 e da leggi vigenti nel paese di installazione
				QUADRO NUMERO				-
				DIS.	DATA	FIRME	DEG P ICI CALDAIE Spa	
				VISTO	04/15	LB		
				APPROV.	04/15	AP		
				QDEG21-1				FOGLIO 1
00	Prima edizione	04/15	LB					T.F. 30
REV.	MODIFICA	DATA	FIRME	SOST. DA	SOST. IL	FILE	QDEG21-1	

00	First edition	04/15	LB	VISTO	AP	ICI CALDAIE	ICI CALDAIE SpA Campagnola di Zevio Verona ITALY	DEG P ICI CALDAIE Spa	QDEG21-1	=	+
REV.	MODIFICA	DATA	FIRMA	APPR.	AP						

0 1 2 3 4 5 6 7 8 9

A

B

C

D

E

F

A

B

C

D

E

F

				DATA	04/15
				DISEGN.	LB
00	First edition	04/15	LB	VISTO	AP
REV.	MODIFICA	DATA	FIRMA	APPR.	AP



ICI CALDAIE SpA
Campagnola di Zevio
Verona ITALY

DEG P
ICI CALDAIE Spa
Riserva
ОГРАНИЧЕНИЯ

QDEG21-1	=	
	+	
	-	FG. 3
		F.S. 4

0 1 2 3 4 5 6 7 8 9

Multifoglio/File	Fg/Sh	Descrizione	Description
Q-DEG21-1	1	Presentazione	Presentation
	2	Dati progetto	Design data
	3	Riserva	Spare
	4	Lista fogli	Sheets list
	5	Riserva	Spare
	6	Layout quadro	Panel layout
	7	Layout quadro	Panel layout
	8	Potenza quadro	Board power supply
	9	Potenza quadro	Board power supply
	10	Alimentazione ausiliari	Auxiliaries supply
	11	Accessori quadro	Board accessories
	12	Circuiti di sicurezza	Safety circuits
	13	Scheda sicurezza pressostato di massima	High pressure safety card
	14	Pressostato di massima	Safety pressure switch
	15	Canale di sicurezza 1	Safety channel 1
	16	Canale di sicurezza 2	Safety channel 2
	17	Riserva	Spare
	18	HMI	HMI
	19	PLC	PLC
	20	Lista I/O	I/O list
	21	Ingressi digitali	Digital inputs
	22	Ingressi digitali	Digital inputs
	23	Ingressi analogici	Analog inputs
	24	PT1000	PT1000
	25	Riserva	Spare
	26	Valvole	Valves
	27	Segnali esterni	External signals
	28	Segnali esterni	External signals
	29	Lista morsetti	Terminals list
	30	Lista morsetti	Terminals list

				DATA	04/15
				DISEGN.	LB
00	First edition	04/15	LB	VISTO	AP
REV.	MODIFICA	DATA	FIRMA	APPR.	AP



ICI CALDAIE SpA
Campagnola di Zevio
Verona ITALY

DEG P
ICI CALDAIE Spa
Lista fogli
СПИСОК ЛИСТОВ

QDEG21-1			=
			+
			FG. 4
			F.S. 5
			-

0 1 2 3 4 5 6 7 8 9

A

B

C

D

E

F

A

B

C

D

E

F

				DATA	04/15
				DISEGN.	LB
00	First edition	04/15	LB	VISTO	AP
REV.	MODIFICA	DATA	FIRMA	APPR.	AP



ICI CALDAIE SpA
Campagnola di Zevio
Verona ITALY

DEG P
ICI CALDAIE Spa
Riserva
ОГРАНИЧЕНИЯ

QDEG21-1		=	
		+	
		-	
			FG. 5
			F.S. 6

0 1 2 3 4 5 6 7 8 9

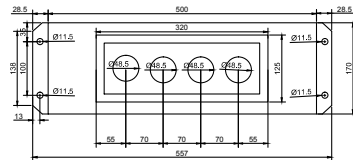
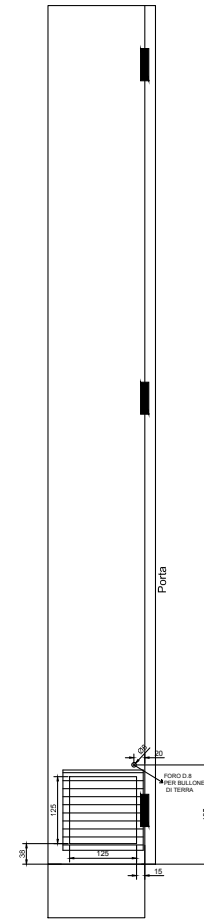
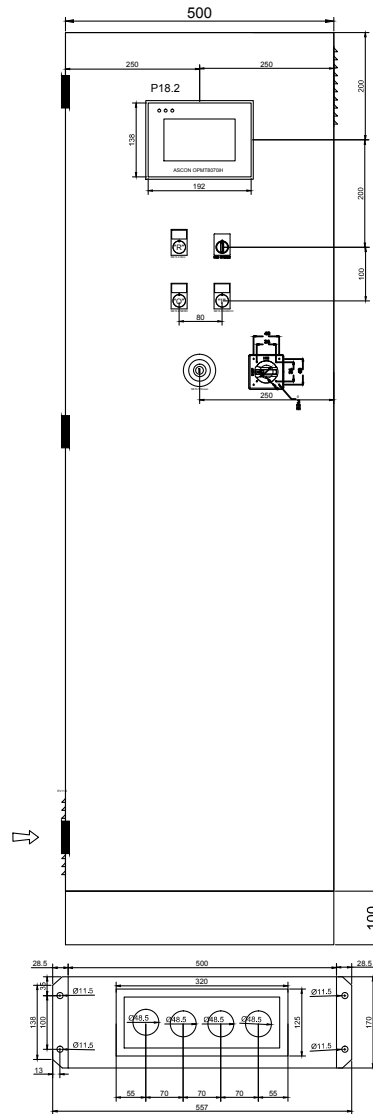
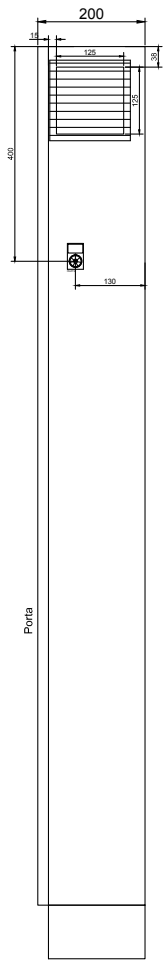

DATA	04/15
DISEGN.	LB
00 First edition	04/15 LB VISTO AP
REV. MODIFICA	DATA FIRMA APPR. AP



ICI CALDAIE SpA
Campagnola di Zevio
Verona ITALY

SOST. IL : SOST. DA : FILE : QDEG21-1

DEG P
ICI CALDAIE Spa
Layout quadro
ВНЕШНЯЯ КОМПАНОВКА ШКАФА УПРАВЛЕНИЯ

QDEG21-1	=	
	+	
	-	FG. 6
		F.S. 7

0 1 2 3 4 5 6 7 8 9

A

B

C

D

E

F

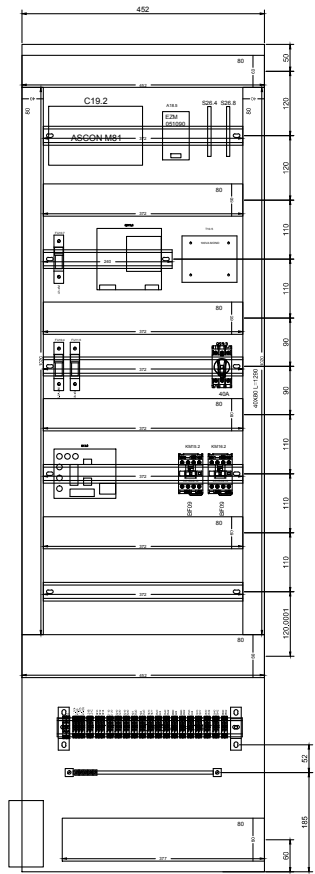

				DATA	04/15
				DISEGN.	LB
00	First edition	04/15	LB	VISTO	AP
REV.	MODIFICA	DATA	FIRMA	APPR.	AP



ICI CALDAIE SpA
Campagnola di Zevio
Verona ITALY
FILE : QDEG21-1

DEG P
ICI CALDAIE Spa
Layout quadro
ВНУТРЕННЯЯ КОМПАНОВКА ШКАФА УПРАВЛЕНИЯ

QDEG21-1	=	
	+	
	-	FG. 7
		F.S. 8

0 1 2 3 4 5 6 7 8 9

0 1 2 3 4 5 6 7 8 9

A

B

C

D

E

F

A

B

C

D

E

F

				DATA	04/15
				DISEGN.	LB
00	First edition	04/15	LB	VISTO	AP
REV.	MODIFICA	DATA	FIRMA	APPR.	AP



ICI CALDAIE SpA
Campagnola di Zevio
Verona ITALY

DEG P
ICI CALDAIE Spa
Riserva
ОГРАНИЧЕНИЯ

QDEG21-1	=	
	+	
	-	FG. 8
		F.S. 9

0 1 2 3 4 5 6 7 8 9

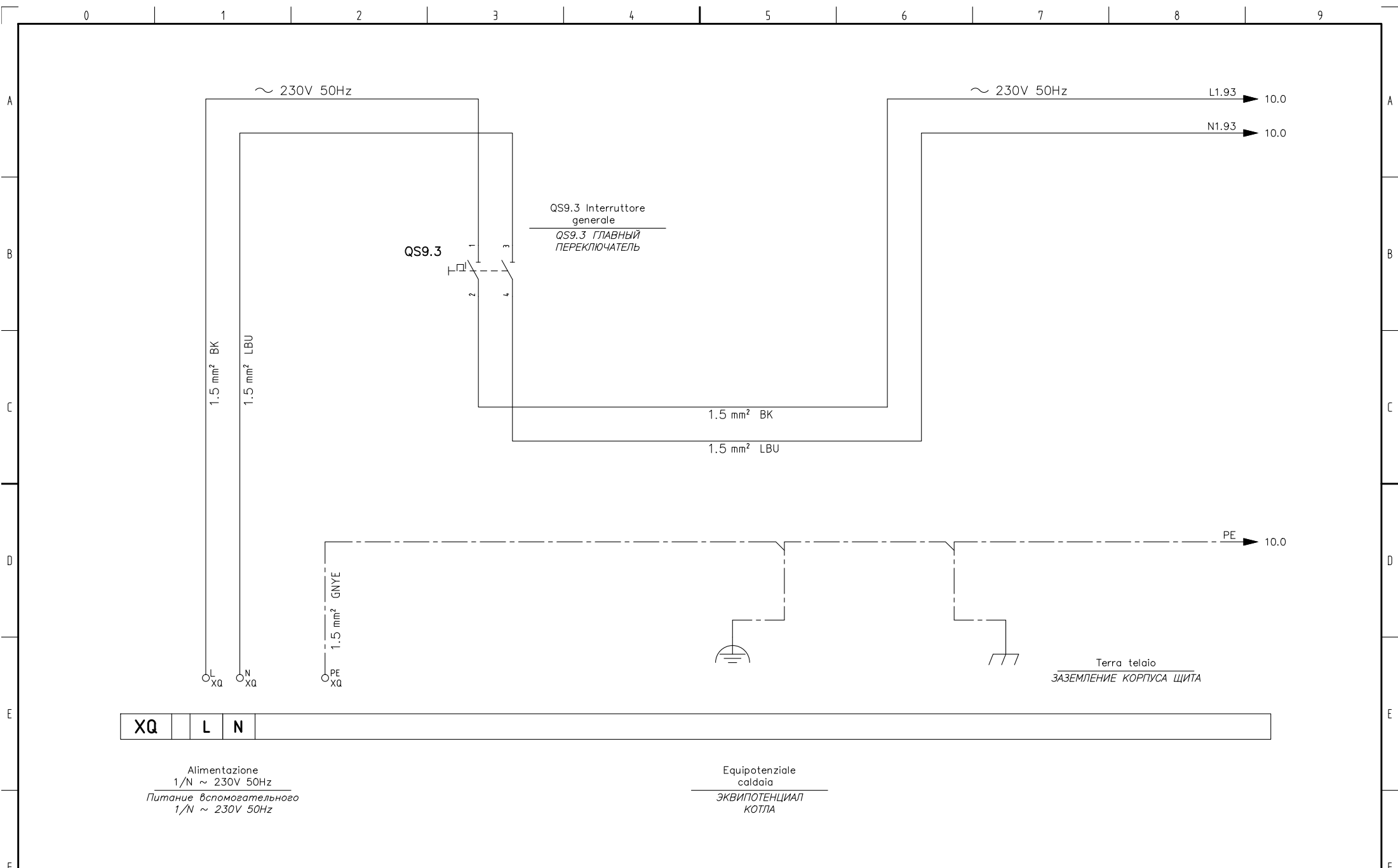

XQ		L	N
----	--	---	---

Alimentazione
1/N ~ 230V 50Hz
Питание вспомогательного
1/N ~ 230V 50Hz

Equipotenziale
caldaia
ЭКВИПОТЕНЦИАЛ
КОТЛА

DATA	04/15	ICICALDAIE	ICI CALDAIE SpA Campagnola di Zevio Verona ITALY	DEG P ICI CALDAIE Spa Distribuzione potenza quadro МОЩНОСТЬ	QDEG21-1	=				
DISEGN.	LB					+				
00 First edition	04/15 LB VISTO AP						FG. 9			
REV.	MODIFICA	DATA	FIRMA	APPR.	AP	SOST. IL :	SOST. DA :	FILE : QDEG21-1	-	FG. 10

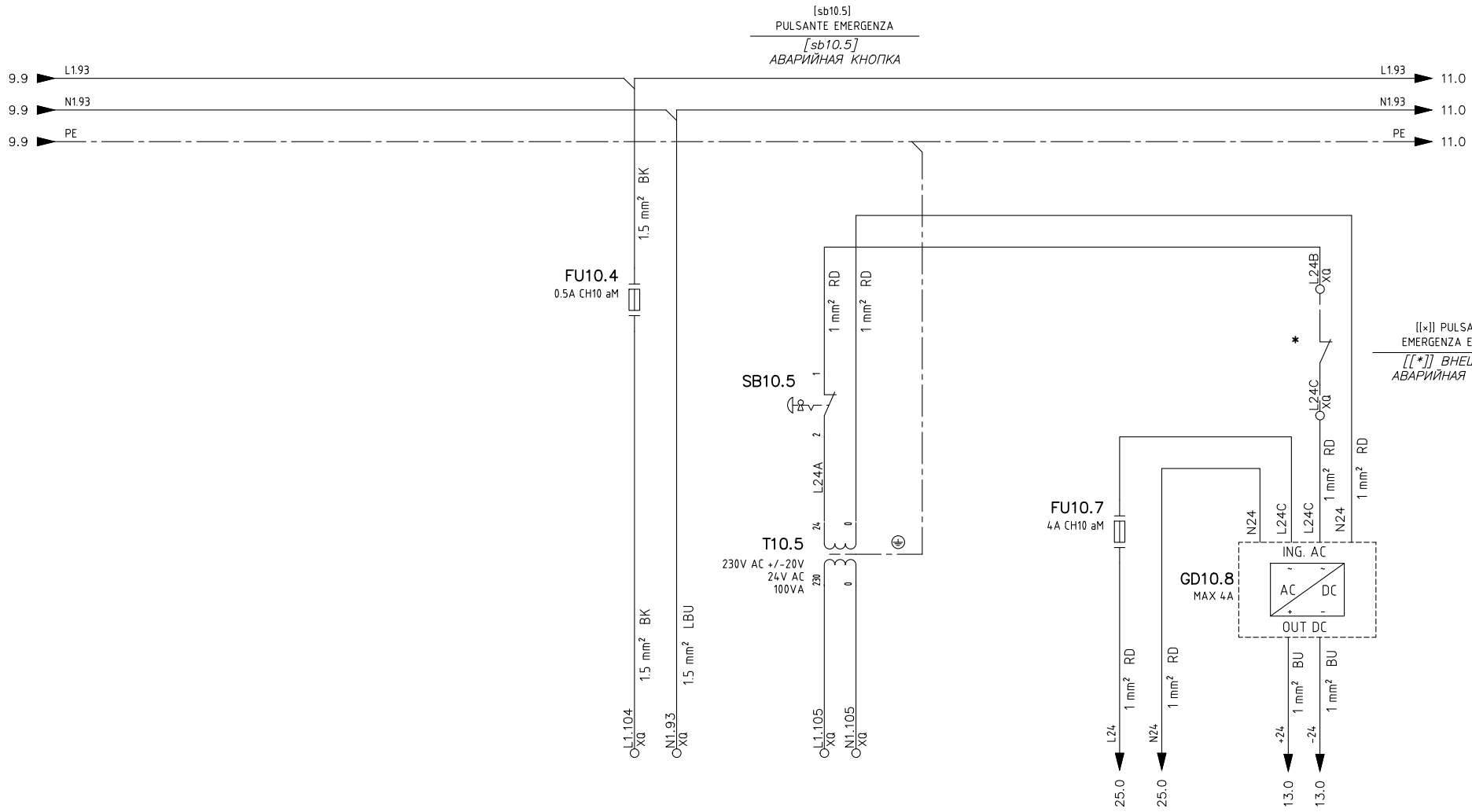

[[x]] PULSANTE EMERGENZA ESTERNO
[[*]] ВНЕШНЯЯ АВАРИЙНАЯ КНОПКА

XQ	L1.104	N1.93	L1.105	N1.105	L24B	L24C
----	--------	-------	--------	--------	------	------

PREDISPOSIZIONE UPS
ПОДГОТОВКА ИБП

ALIMENTAZIONE AUSILIARI [24VAC]
ПИТАНИЕ ВСПОМОГАТЕЛЬНОГО ОБОРУДОВАНИЯ [24VAC]

ALIMENTAZIONE AUSILIARI [24VDC]
ПИТАНИЕ ВСПОМОГАТЕЛЬНОГО ОБОРУДОВАНИЯ [24VDC]

DATA	04/15	ICICALDAIE	ICI CALDAIE SpA Campagnola di Zevio Verona ITALY	DEG P ICI CALDAIE Spa	QDEG21-1	=	+
DISEGN.	LB						
00 First edition	04/15	SOST. IL :	SOST. DA :	FILE : QDEG21-1	Alimentazione ausiliari ПИТАНИЕ ВСПОМОГАТЕЛЬНОГО ОБОРУДОВАНИЯ	-	FG. 10
REV. MODIFICA	DATA FIRMA						APPR. AP

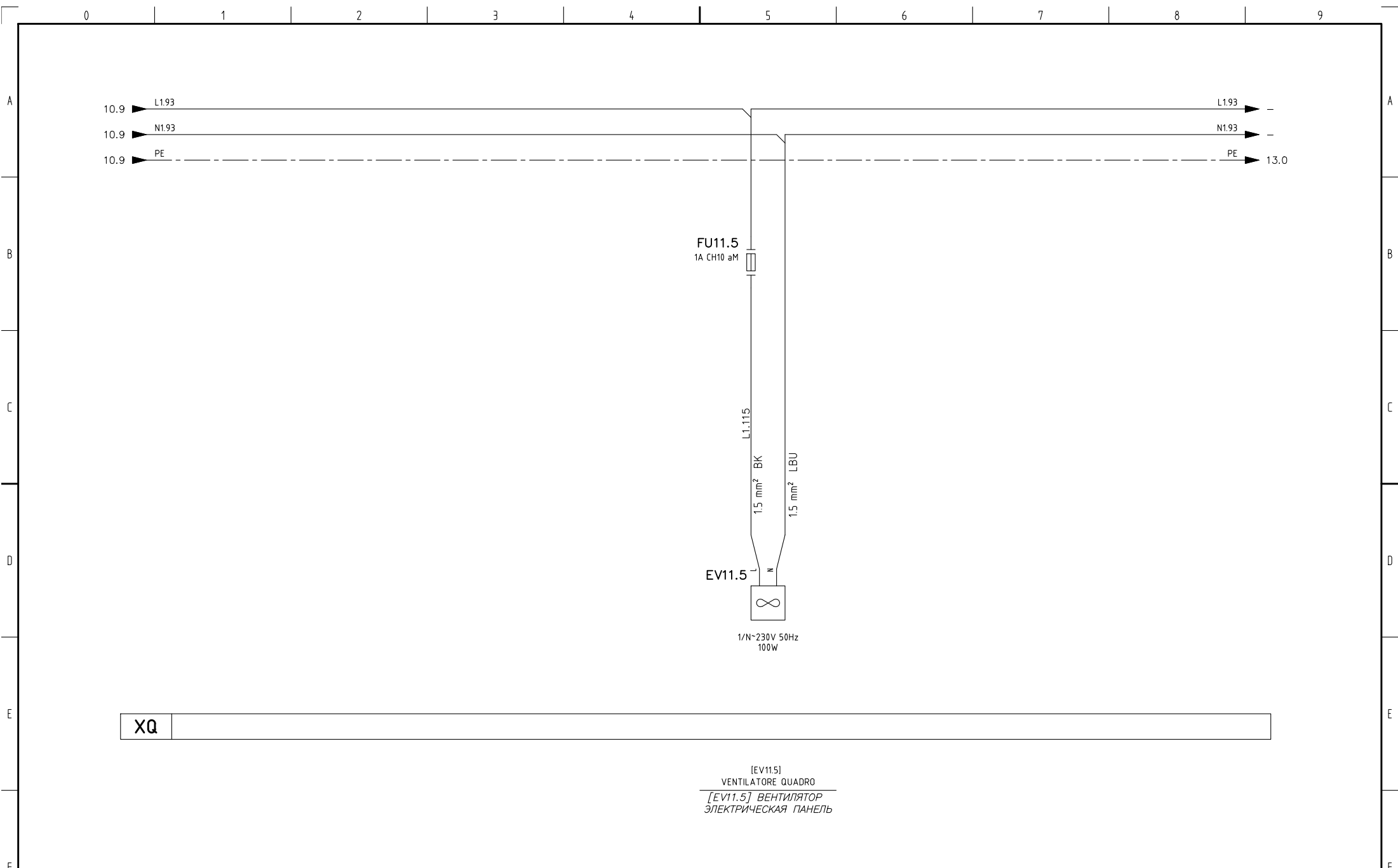

XQ

[EV115]
VENTILATORE QUADRO
[EV11.5] ВЕНТИЛЯТОР
ЭЛЕКТРИЧЕСКАЯ ПАНЕЛЬ

				DATA	04/15	ICICALDAIE	ICI CALDAIE SpA Campagnola di Zevio Verona ITALY	DEG P ICI CALDAIE Spa Ventilatore quadro ВЕНТИЛЯТОР ШКАФА	QDEG21-1	=	
				DISEGN.	LB					+	
00	First edition	04/15	LB	VISTO	AP						FG. 11
REV.	MODIFICA	DATA	FIRMA	APPR.	AP	SOST. IL :	SOST. DA :	FILE : QDEG21-1		-	F.S. 12

Circuiti di sicurezza

ВСПОМОГАТЕЛЬНОЕ ОБОРУДОВАНИЕ

				DATA	04/15	ICICALDAIE	ICI CALDAIE SpA Campagnola di Zevio Verona ITALY	DEG P ICI CALDAIE Spa Circuiti di sicurezza ВСПОМОГАТЕЛЬНОЕ ОБОРУДОВАНИЕ	QDEG21-1	=			
				DISEGN.	LB								
00	First edition	04/15	LB	VISTO	AP								
REV.	MODIFICA	DATA	FIRMA	APPR.	AP	SOST. IL :	SOST. DA :	FILE : QDEG21-1		-	F.S. 13		

[SB13.2]
 RESET ALLARMI
 [SB13.2] СБРОС
 СИГНАЛОВ ТРЕВОГИ

10.8 +24 → 14.0 +24

S13.0

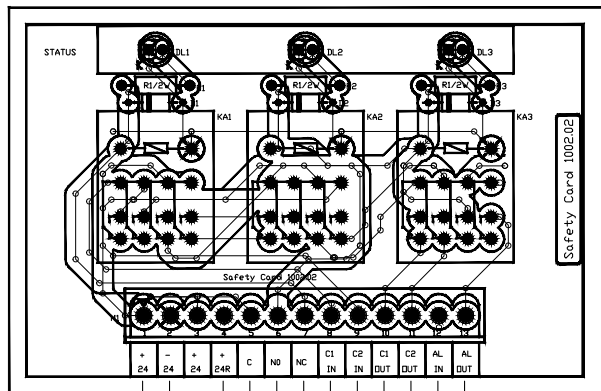

SB13.2

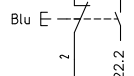

1320

134.0 → 21.1
 2110 → 21.0
 134.2 → 16.0
 134.0 → 15.0
 1622 → 16.0
 1520 → 15.0

1412 → 14.1
 1414 → 14.1
 1410 → 14.1

10.8 -24 → 14.0 -24

11.9 PE → 14.0 PE

XQ

DATA	04/15
DISEGN.	LB
00 First edition	04/15 LB VISTO AP
REV. MODIFICA	DATA FIRMA APPR. AP



ICI CALDAIE SpA
 Campagnola di Zevio
 Verona ITALY

DEG P
 ICI CALDAIE Spa
 Sicurezze
 ПРЕДОХРАНИТЕЛИ

QDEG21-1

FG. 13
 F.S. 14

SOST. IL : SOST. DA : FILE : QDEG21-1

0 1 2 3 4 5 6 7 8 9

[S14.3]
 PRESSOSTATO DI SICUREZZA
 [S14.3]
 ПРЕДОХРАНИТЕЛЬНОЕ РЕЛЕ ДАВЛЕНИЕ

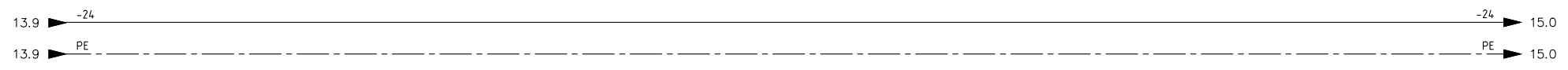
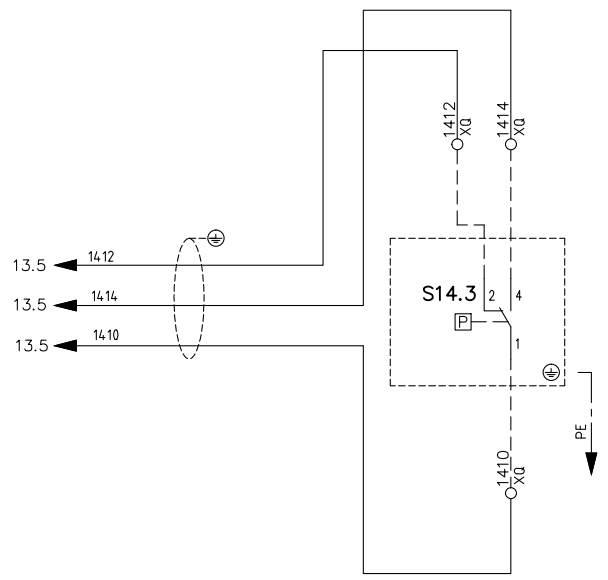
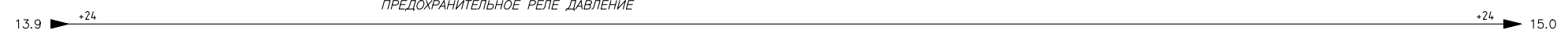

XQ	1412	1414	1410
----	------	------	------

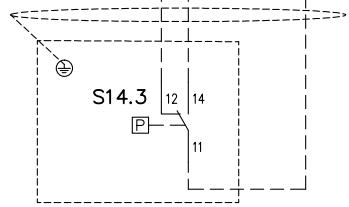

DATA	04/15	ICICALDAIE	ICI CALDAIE SpA Campagnola di Zevio Verona ITALY	DEG P ICI CALDAIE Spa	QDEG21-1	=	+		
DISEGN.	LB								
00	First edition	04/15	LB	VISTO	AP	Pressostato di massima ПРЕДОХРАНИТЕЛЬНОЕ РЕЛЕ ДАВЛЕНИЕ		FG. 14	
REV.	MODIFICA	DATA	FIRMA	APPR.	AP	SOST. IL :	SOST. DA :	FILE : QDEG21-1	FG. 15

0 1 2 3 4 5 6 7 8 9

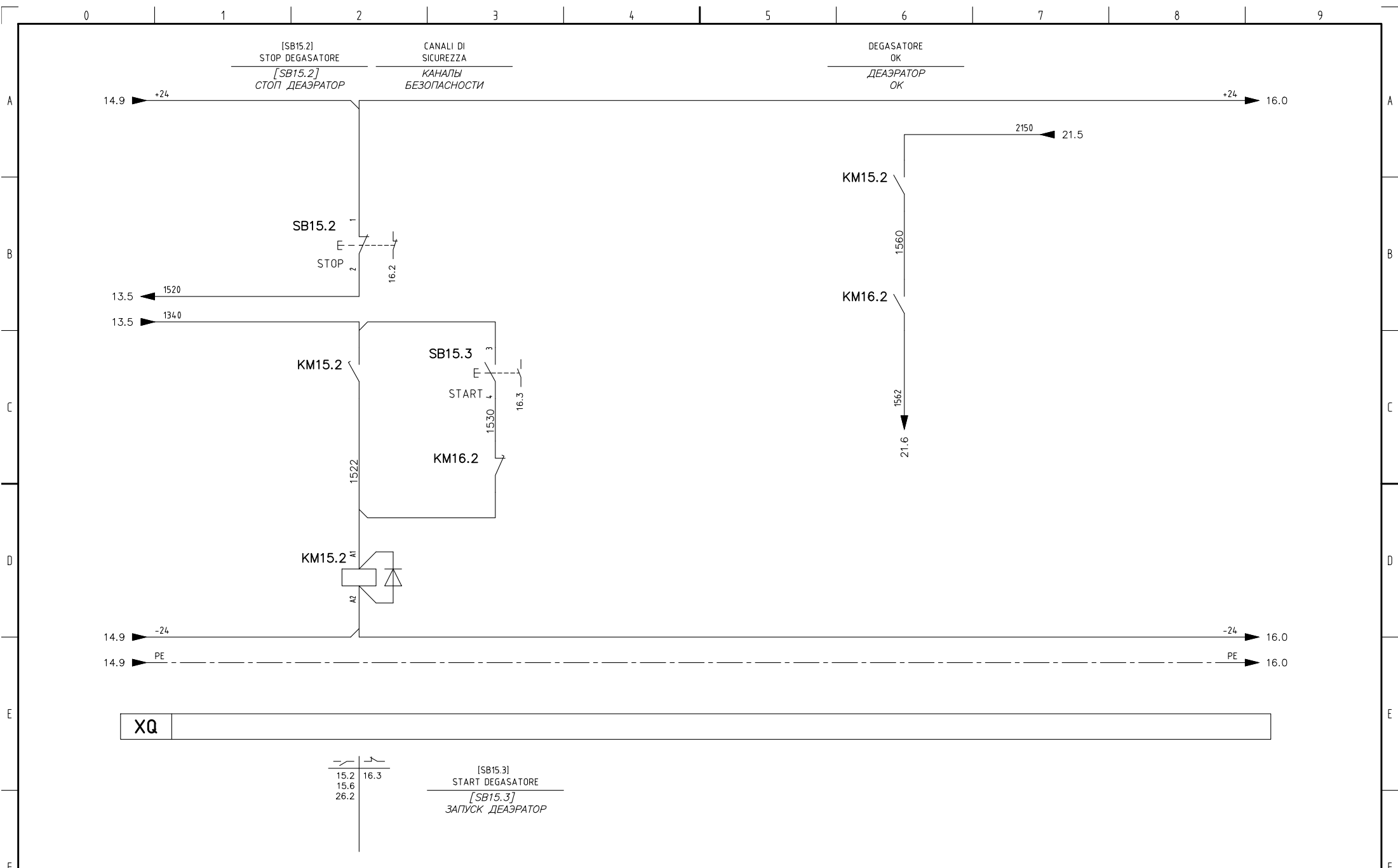

DATA	04/15	ICICALDAIE	ICI CALDAIE SpA Campagnola di Zevio Verona ITALY	DEG P ICI CALDAIE Spa	QDEG21-1	=
DISEGN.	LB					
00 First edition	04/15 LB VISTO AP	SOST. IL :	SOST. DA :	FILE : QDEG21-1		
REV.	MODIFICA	DATA	FIRMA	APPR.	AP	

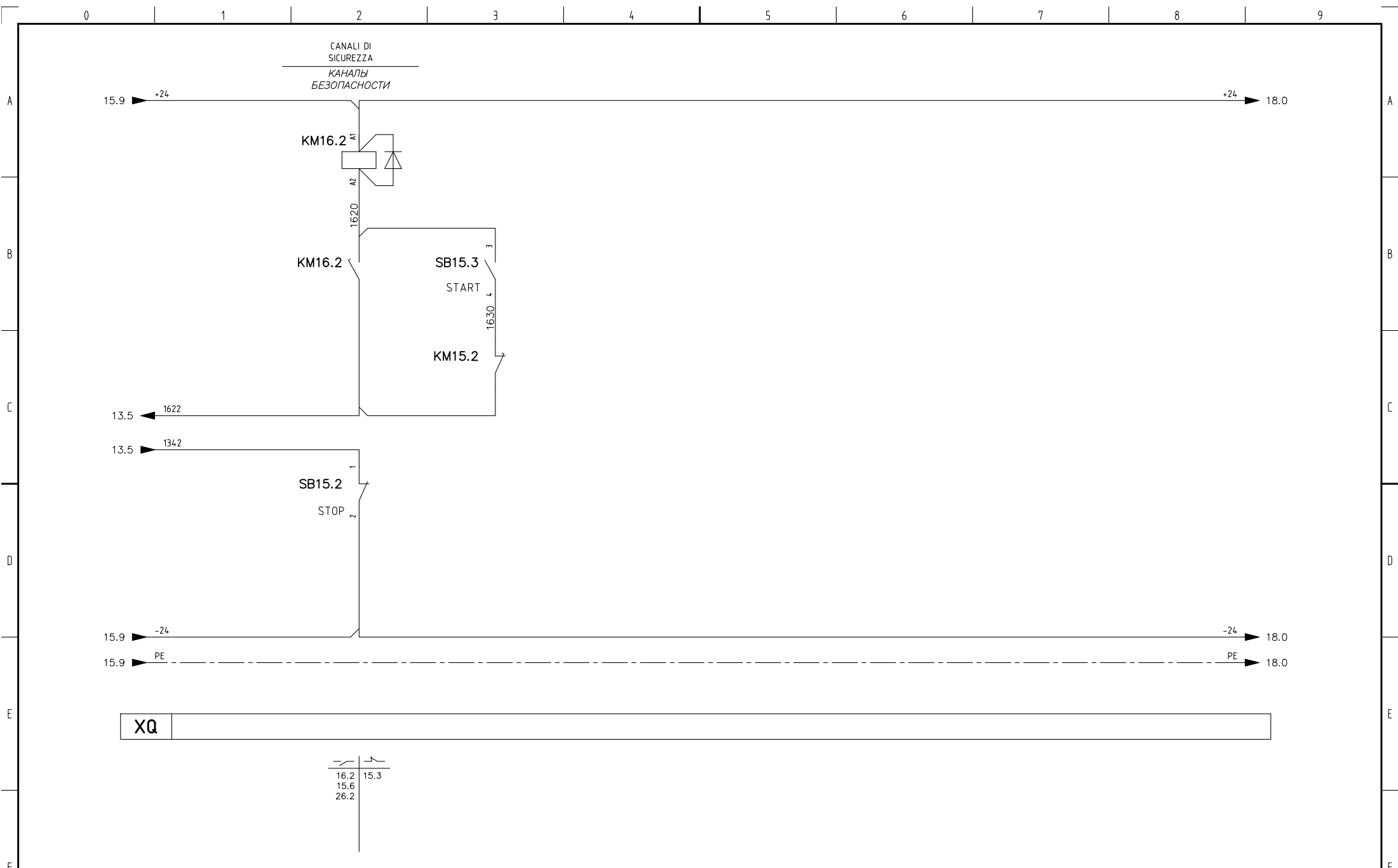

				DATA	04/15	ICICALDAIE	ICI CALDAIE SpA Campagnola di Zevio Verona ITALY	DEG P ICI CALDAIE Spa Canale di sicurezza 2 КАНАЛЫ КАНАЛЫ 2	QDEG21-1	=
				DISEGN.	LB				+	
00	First edition	04/15	LB	VISTO	AP				FG. 16	
REV.	MODIFICA	DATA	FIRMA	APPR.	AP	SOST. IL :	SOST. DA :	FILE : QDEG21-1	-	F.S. 17

0 1 2 3 4 5 6 7 8 9

A

B

C

D

E

F

A

B

C

D

E

F

				DATA	04/15
				DISEGN.	LB
00	First edition	04/15	LB	VISTO	AP
REV.	MODIFICA	DATA	FIRMA	APPR.	AP



ICI CALDAIE SpA
Campagnola di Zevio
Verona ITALY

DEG P
ICI CALDAIE Spa
Riserva
ОГРАНИЧЕНИЯ

QDEG21-1	=	
	+	
	-	FG. 17
		F.S. 18

0 1 2 3 4 5 6 7 8 9

[P18.2] HMI
 ASCON OPMT8070IE
 [P18.2] HMI
 ASCON OPMT8070IE

16.9 → +24 → 19.0

P18.2



RS485 (maschio-male)
 COM1 2+ 1- => RETRASM.
 COM3 8+ 7- => PLC

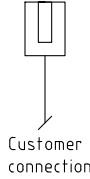
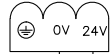
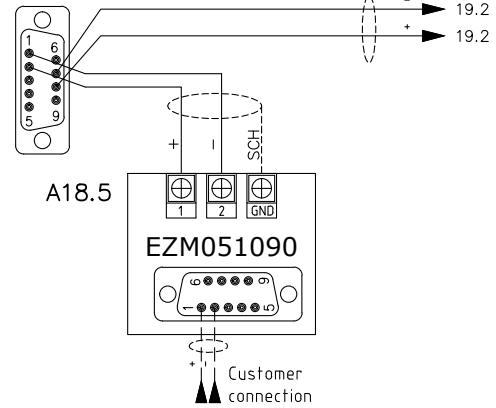

Customer connection

A18.5
 EZM051090



Customer connection

16.9 → -24 → 19.0

16.9 → PE → 19.0

XQ

				DATA	04/15	ICICALDAIE	ICI CALDAIE SpA Campagnola di Zevio Verona ITALY	DEG P ICI CALDAIE Spa	QDEG21-1	=				
				DISEGN.	LB									
00	First edition	04/15	LB	VISTO	AP									FG. 18
REV.	MODIFICA	DATA	FIRMA	APPR.	AP	SOST. IL :	SOST. DA :	FILE : QDEG21-1			F.S. 19			

0 1 2 3 4 5 6 7 8 9

0 1 2 3 4 5 6 7 8 9

A
B
C
D
E
F

[C19.2]
PLC ASCON M81
[C19.2]
PLC ASCON M81

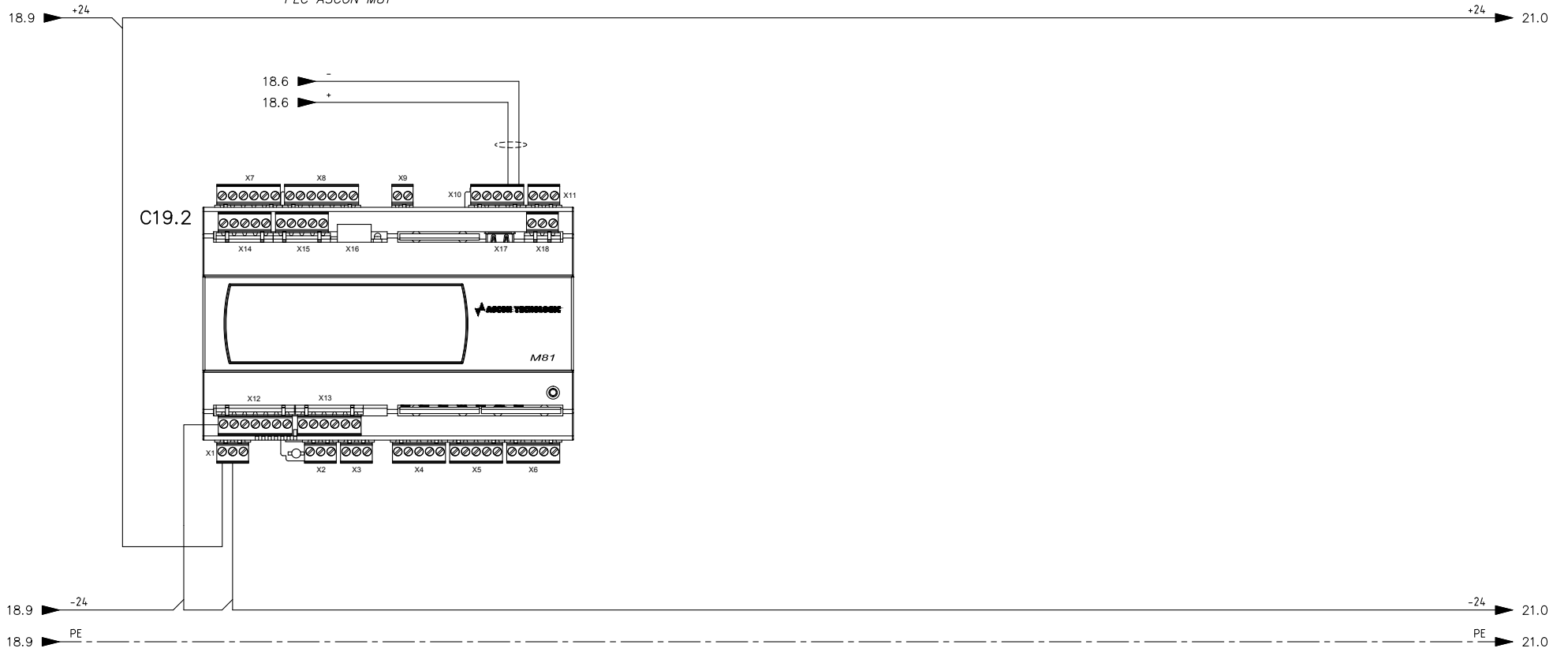

				DATA	04/15	ICICALDAIE	ICI CALDAIE SpA Campagnola di Zevio Verona ITALY	DEG P ICI CALDAIE Spa	QDEG21-1	=				
				DISEGN.	LB									
00	First edition	04/15	LB	VISTO	AP									FG. 19
REV.	MODIFICA	DATA	FIRMA	APPR.	AP	SOST. IL :	SOST. DA :	PLC PLC		-	F.S. 20			

0 1 2 3 4 5 6 7 8 9

A



B

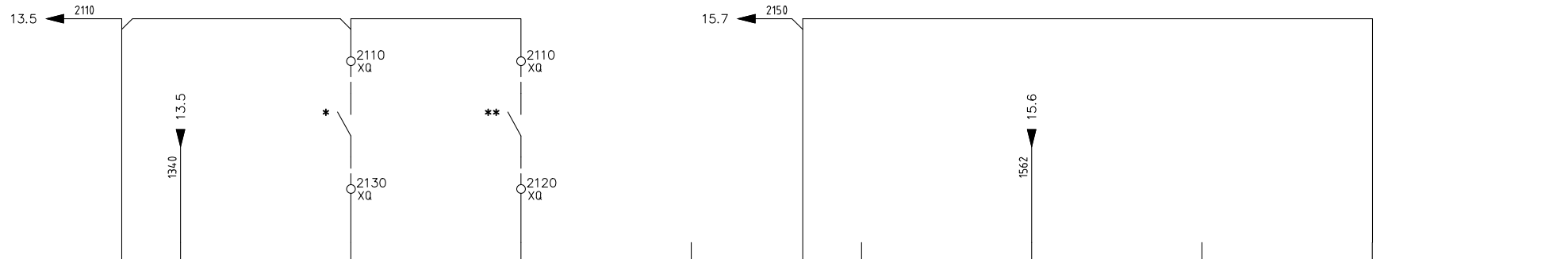

C

X4-M X4-DI1	X4-DI2	X4-DI3	X4-DI4	X5-M X5-DI5	X5-DI6	X5-DI7	X5-DI8
INPUT 1	INPUT 2	INPUT 3	INPUT 4	INPUT 5	INPUT 6	INPUT 7	INPUT 8
ALLARME ALTA PRESSIONE <i>СИГНАЛ ТРЕВОГИ ВЫСОКОГО ДАВЛЕНИЯ</i>	MINIMO LIVELLO <i>МИНИМАЛЬНЫЙ УРОВЕНЬ</i>	MASSIMO LIVELLO <i>МАКСИМАЛЬНЫЙ УРОВЕНЬ</i>	RISERVA <i>ОГРАНИЧЕНИЯ</i>	RISERVA <i>ОГРАНИЧЕНИЯ</i>	DEGASATORE OK <i>ДЕАЭРАТОР OK</i>	RISERVA <i>ОГРАНИЧЕНИЯ</i>	RISERVA <i>ОГРАНИЧЕНИЯ</i>
C19.2 ASCON M81							

D

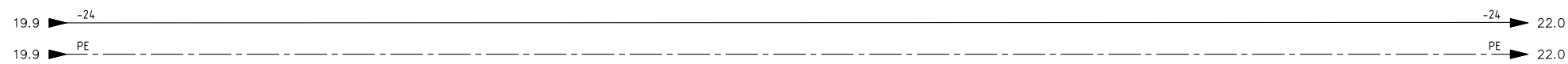

E

XQ	2110 2120	2110 2130
----	-----------	-----------

F

DATA	04/15	ICICALDAIE	ICI CALDAIE SpA Campagnola di Zevio Verona ITALY		DEG P ICI CALDAIE Spa Ingressi digitali ЦИФРОВЫЕ ВХОДНЫЕ УСТРОЙСТВА		QDEG21-1		=	
DISEGN.	LB								+	
00 First edition	04/15 LB VISTO AP								FG. 21	
REV.	MODIFICA	DATA	FIRMA	APPR.	AP	SOST. IL :	SOST. DA :	FILE : QDEG21-1	-	FG. 22

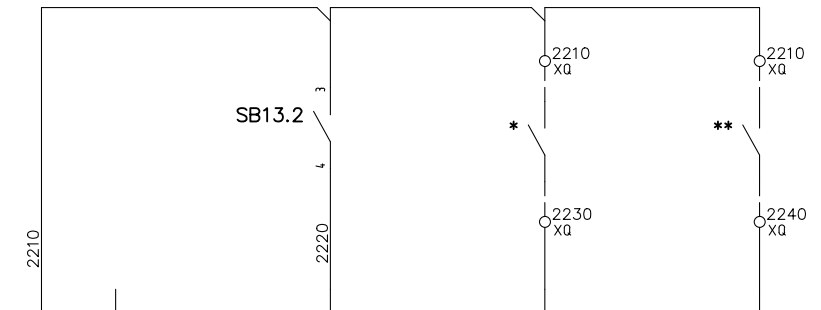
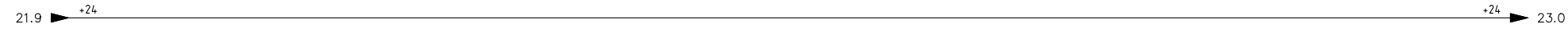

X6-M	X6-DI9	X6-DI10	X6-DI11	X6-DI12
INPUT 9	INPUT 10	INPUT 11	INPUT 12	
RÈSERVE <i>ОГРАНИЧЕНИЯ</i>	RESET ALARMES <i>СБРОС СИГНАЛОВ ТРЕВОГИ</i>	RISERVA <i>ОГРАНИЧЕНИЯ</i>	RISERVA <i>ОГРАНИЧЕНИЯ</i>	
C19.2 ASCON M81				

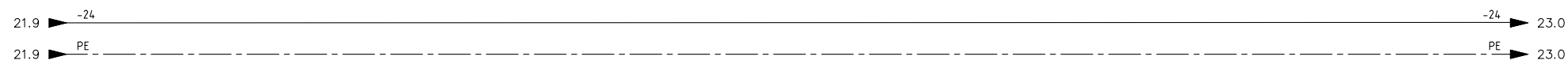

XQ		2210	2230		2210	2240
-----------	--	-------------	-------------	--	-------------	-------------

				DATA	04/15	ICICALDAIE	ICI CALDAIE SpA Campagnola di Zevio Verona ITALY	DEG P ICI CALDAIE Spa Ingressi digitali ЦИФРОВЫЕ ВХОДНЫЕ УСТРОЙСТВА	QDEG21-1	=				
				DISEGN.	LB									
00	First edition	04/15	LB	VISTO	AP									
REV.	MODIFICA	DATA	FIRMA	APPR.	AP	SOST. IL :	SOST. DA :	FILE : QDEG21-1		-	F.S. 23			

0 1 2 3 4 5 6 7 8 9

A
B
C
D
E
F

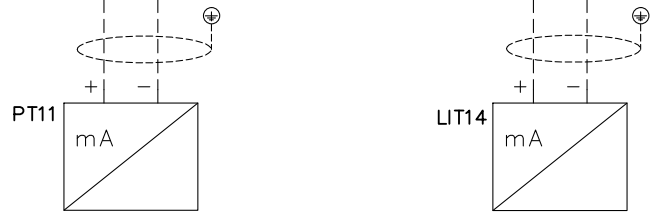
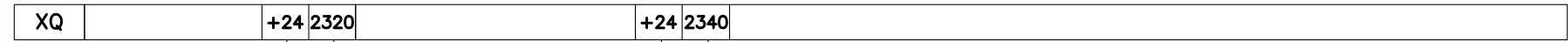
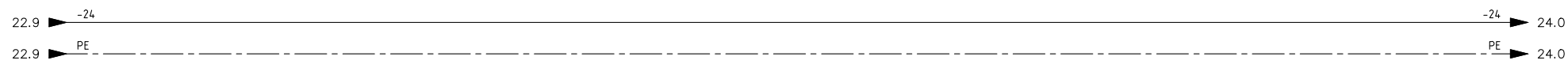
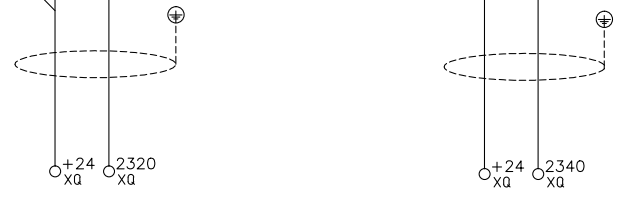
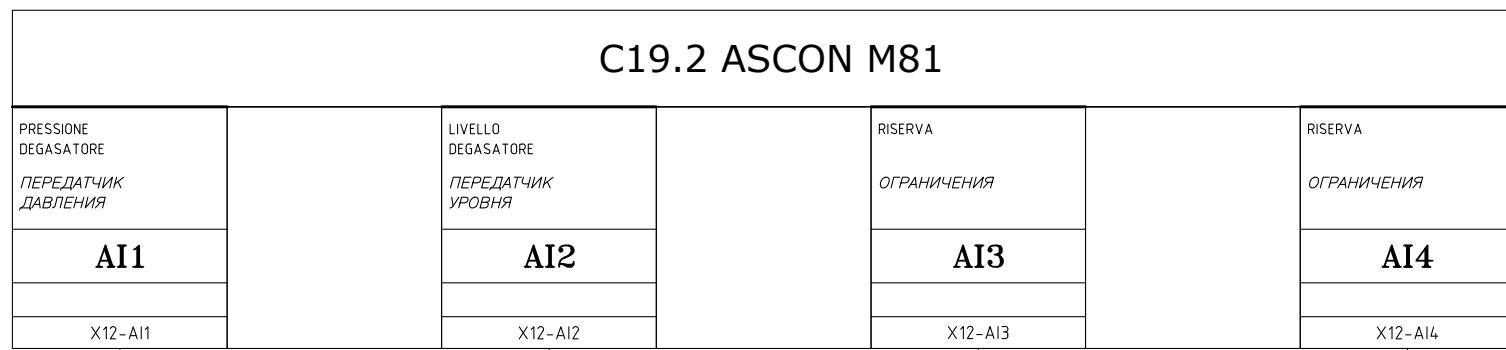
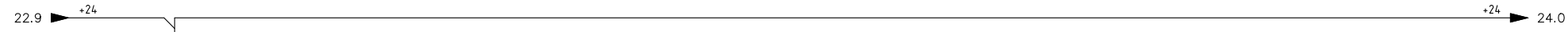

		DATA	04/15	ICICALDAIE	ICI CALDAIE SpA Campagnola di Zevio Verona ITALY	DEG P ICI CALDAIE Spa Ingressi analogici АНАЛОГОВЫЕ ВХОДНЫЕ УСТРОЙСТВА	QDEG21-1				
		DISEGN.	LB								
00	First edition	04/15	LB					VISTO	AP		
REV.	MODIFICA	DATA	FIRMA	APPR.	AP	SOST. IL :	SOST. DA :	FILE : QDEG21-1	F.S. 24		

0 1 2 3 4 5 6 7 8 9

0 1 2 3 4 5 6 7 8 9

A
B
C
D
E
F

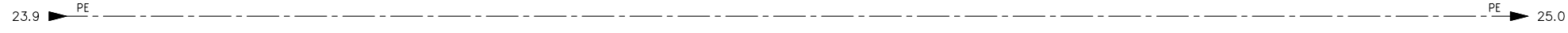
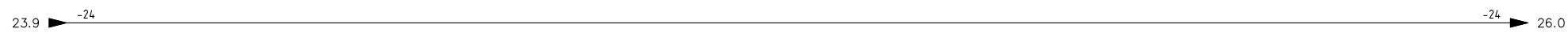
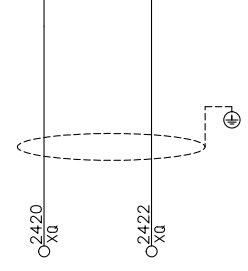
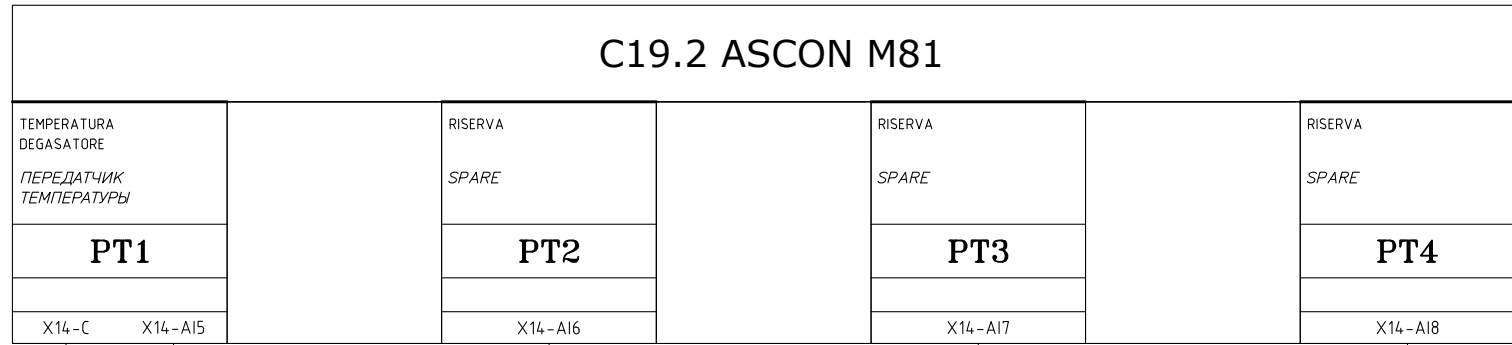
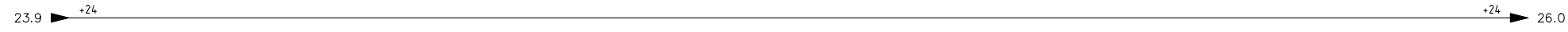

				DATA	04/15	ICICALDAIE	ICI CALDAIE SpA Campagnola di Zevio Verona ITALY	DEG P ICI CALDAIE Spa	QDEG21-1						
				DISEGN.	LB										
00	First edition	04/15	LB	VISTO	AP										
REV.	MODIFICA	DATA	FIRMA	APPR.	AP	SOST. IL :	SOST. DA :	FILE : QDEG21-1				F.S. 25			

0 1 2 3 4 5 6 7 8 9

0 1 2 3 4 5 6 7 8 9

A
B
C
D
E
F

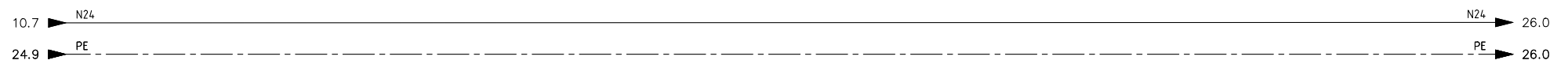
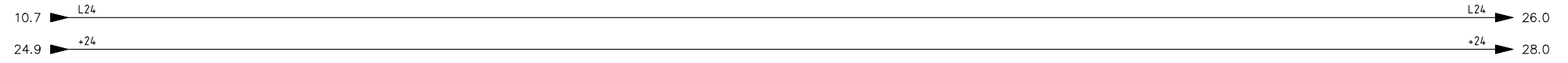

XQ

				DATA	04/15	ICICALDAIE	ICI CALDAIE SpA Campagnola di Zevio Verona ITALY	DEG P ICI CALDAIE Spa	QDEG21-1	=				
				DISEGN.	LB									
00	First edition	04/15	LB	VISTO	AP									FG. 25
REV.	MODIFICA	DATA	FIRMA	APPR.	AP	SOST. IL :	SOST. DA :	FILE : QDEG21-1		-	F.S. 26			

0 1 2 3 4 5 6 7 8 9

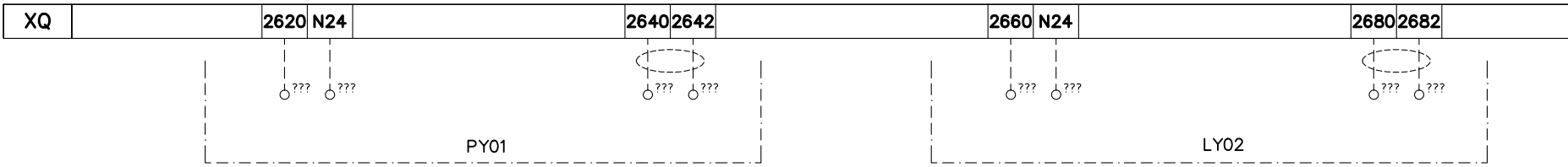
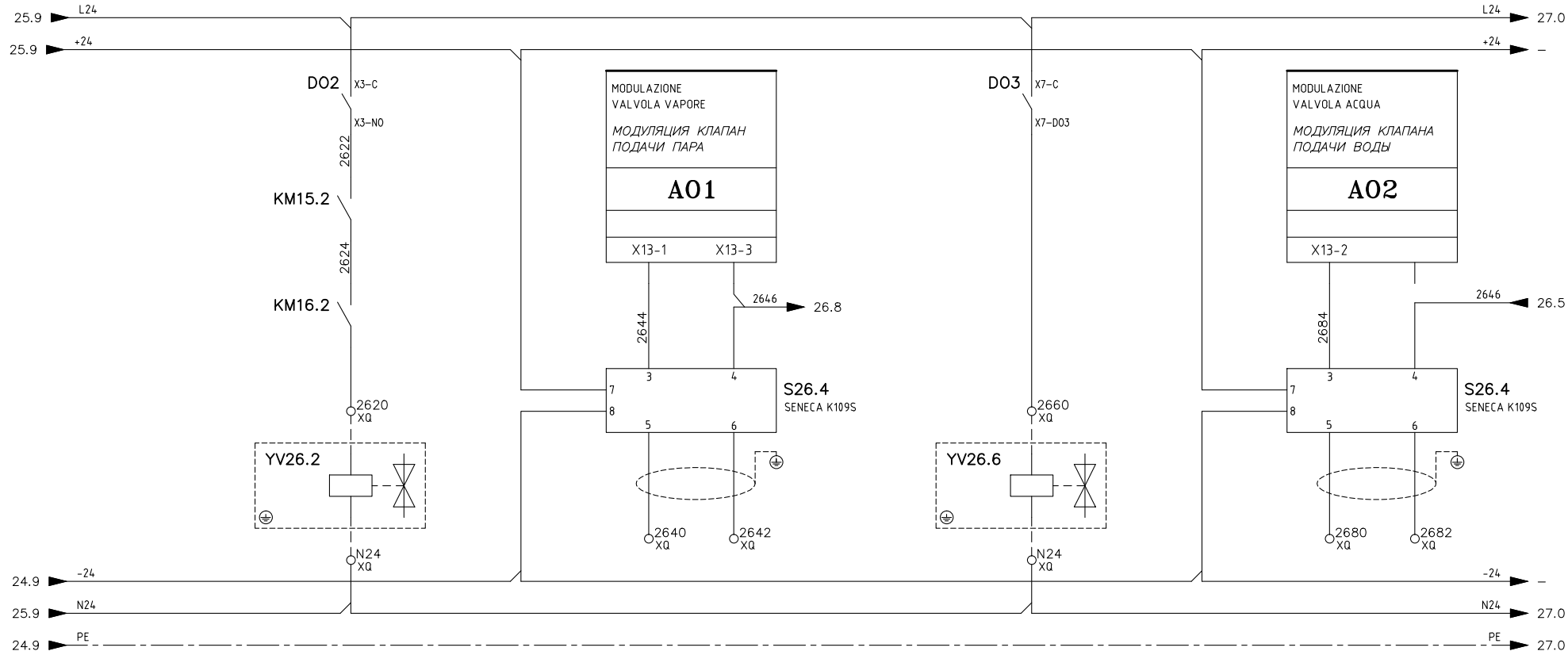

[YV26.2]
ELETTRIVALVOLA ARIA VALVOLA VAPORE
[YV26.2] ЭЛЕКТРОКЛАПАН
ВОЗДУШНЫЙ ПОДАЧИ ПАРА

MODULAZIONE
VALVOLA VAPORE
МОДУЛЯЦИЯ
КЛАПАНА ПОДАЧИ ПАРА

[YV26.6] ELETTRIVALVOLA
ARIA PER VALVOLA ACQUA
[YV26.6] ЭЛЕКТРОКЛАПАН
ВОЗДУШНЫЙ ПОДАЧИ ВОДЫ

MODULAZIONE
VALVOLA ACQUA
МОДУЛЯЦИЯ
КЛАПАНА ПОДАЧИ ВОДЫ

00	First edition	04/15	LB	VISTO	AP		ICI CALDAIE SpA Campagnola di Zevio Verona ITALY	DEG P ICI CALDAIE Spa Valvole КЛАПАН	QDEG21-1	=	FG. 26 F.S. 27
REV.	MODIFICA	DATA	FIRMA	APPR.	AP					SOST. IL :	

0 1 2 3 4 5 6 7 8 9

A
B
C
D
E
F

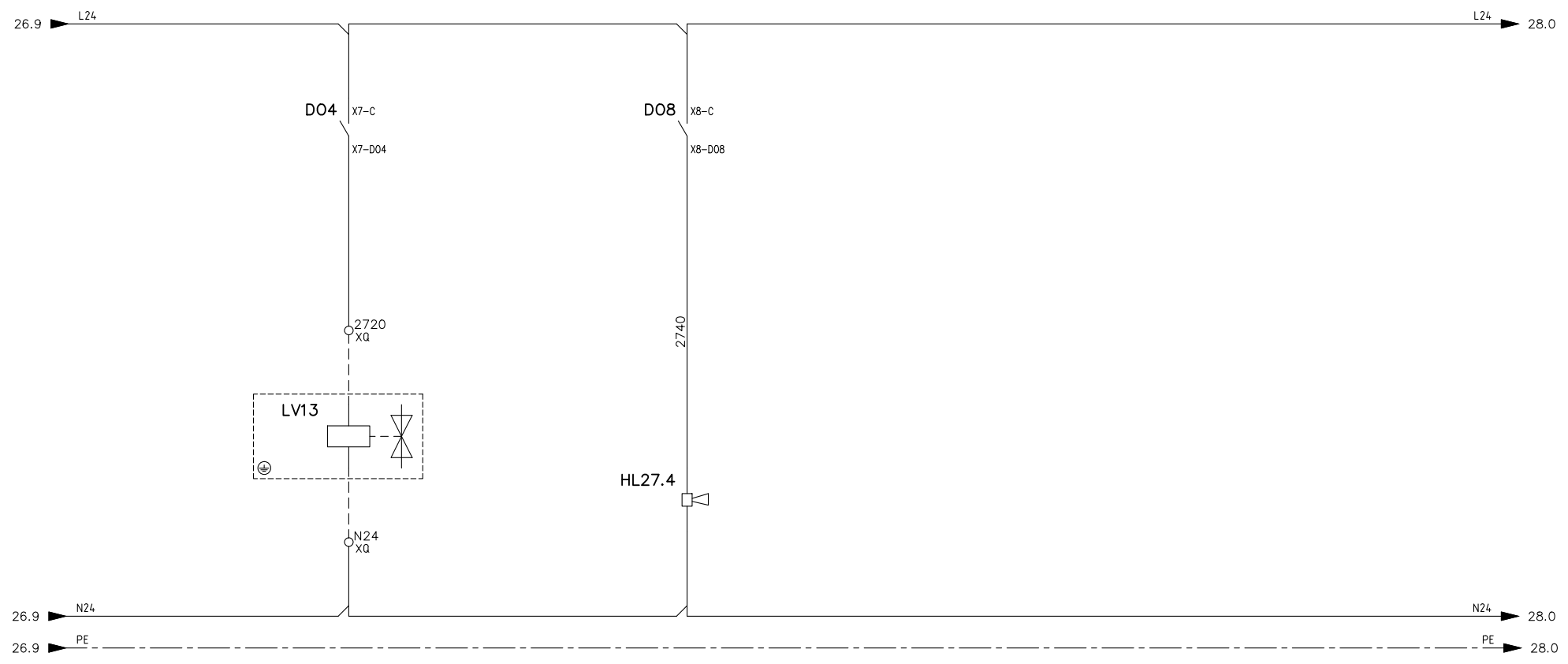

XQ	2720	N24
----	------	-----

[YV27.2]
 VALVOLA TROPPO PIENO
 [YV27.2]
 КЛАПАН ПЕРЕПОЛНЕНИЕ

[HL27.4]
 ALLARME ACUSTICO
 [HL27.4]
 АКУСТИЧЕСКИЙ СИГНАЛ

DATA	04/15	ICICALDAIE	ICI CALDAIE SpA Campagnola di Zevio Verona ITALY	DEG P ICI CALDAIE Spa	QDEG21-1	=	+
DISEGN.	LB						
00	First edition	04/15	LB	VISTO	AP	-	FG. 27 F.S. 28
REV.	MODIFICA	DATA	FIRMA	APPR.	AP		
SOST. IL :		SOST. DA :		FILE : QDEG21-1			

0 1 2 3 4 5 6 7 8 9

0 1 2 3 4 5 6 7 8 9

A

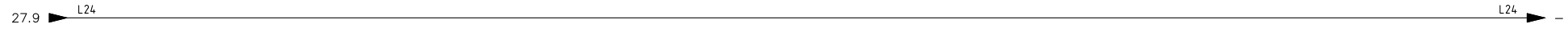

B

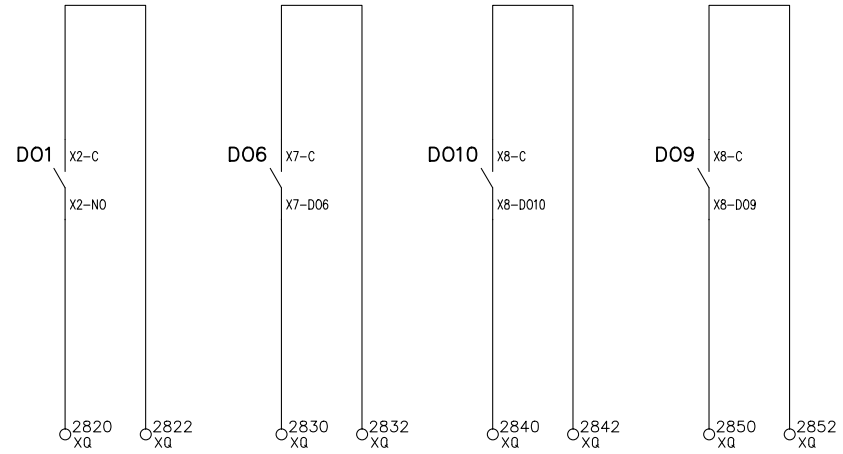

C

D

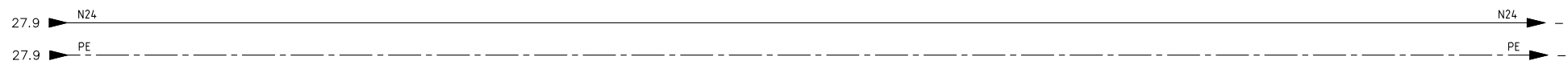

E

XQ	2820 2822	2830 2832	2840 2842	2850 2852
----	-----------	-----------	-----------	-----------

MINIMO LIVELLO
DEG PER CALDAIA 1
МИНИМАЛЬНЫЙ
УРОВЕНЬ КОТЕЛ 1

MINIMO LIVELLO
DEG PER CALDAIA 2
МИНИМАЛЬНЫЙ
УРОВЕНЬ КОТЕЛ 2

MINIMO LIVELLO
DEG PER CALDAIA 3
МИНИМАЛЬНЫЙ
УРОВЕНЬ КОТЕЛ 3

CUMULATIVO
ALLARMI
СОВОКУПНОСТЬ
СИГНАЛОВ ТРЕВОГИ

F

				DATA	04/15	ICICALDAIE	ICI CALDAIE SpA Campagnola di Zevio Verona ITALY	DEG P ICI CALDAIE Spa Segnali esterni ПОДАЧА СИГНАЛОВ	QDEG21-1	=			
				DISEGN.	LB								
00	First edition	04/15	LB	VISTO	AP								
REV.	MODIFICA	DATA	FIRMA	APPR.	AP	SOST. IL :	SOST. DA :	FILE : QDEG21-1		-	F.S. 29		

0 1 2 3 4 5 6 7 8 9

TERMINAL XQ

Alimentazione quadro ПИТАНИЕ ПАНЕЛИ	L N
Predisposizione per UPS ПОДГОТОВКА ИБП	L1.104 N1.93 L1.105 N1.105
Emergenza esterna ВНЕШНЯЯ АВАРИЙНАЯ КНОПКА	L24B L24C
Pressostato di sicurezza ПРЕДОХРАНИТЕЛЬНОЕ РЕЛЕ ДАВЛЕНИЕ	1410 1412 1414
Minimo livello МИНИМАЛЬНЫЙ УРОВЕНЬ	2110 2120
Massimo livello МАКСИМАЛЬНЫЙ УРОВЕНЬ	2110 2130
Riserva ОГРАНИЧЕНИЯ	2210 2230
Riserva ОГРАНИЧЕНИЯ	2210 2240
Trasmittore di pressione ПЕРЕДАТЧИК ДАВЛЕНИЯ	+24 2320
Trasmittore di livello ПЕРЕДАТЧИК УРОВНЯ	+24 2340
Temperatura degasatore ПЕРЕДАТЧИК ТЕМПЕРАТУРЫ	2420 2422
Alimentazione valvola vapore in torretta ЭЛЕКТРОКЛАПАН ВОЗДУШНЫЙ ПОДАЧИ ПАРА	2620 N24

00	First edition	04/15	LB	VISTO	AP
REV.	MODIFICA	DATA	FIRMA	APPR.	AP



ICI CALDAIE Spa
Campagnola di Zevio
Verona ITALY

DEG P
ICI CALDAIE Spa
Lista morsetti
ПЕРЕЧЕНЬ КЛЕММНЫХ КОРОБОК

QDEG21-1	=	
	+	
	-	FG. 29 F.S. 30

TERMINAL XQ

2640
2642



Segnale valvola vapore in torretta
МОДУЛЯЦИЯ КЛАПАН ПОДАЧИ ПАРА

2660
N24



Alimentazione valvola acqua in torretta
ЭЛЕКТРОКЛАПАН ВОЗДУШНЫЙ ПОДАЧИ ВОДЫ

2680
2682



Segnale valvola acqua in torretta
МОДУЛЯЦИЯ КЛАПАН ПОДАЧИ ПАРА

2720
N24



Alimentazione valvola scarico acqua
ЭЛЕКТРОКЛАПАН ВОЗДУШНЫЙ ПОДАЧИ ВОДЫ

2820
2822



Segnale allarme a caldaia 1
МИНИМАЛЬНЫЙ УРОВЕНЬ КОТЕЛ 1

2830
2832



Segnale allarme a caldaia 2
МИНИМАЛЬНЫЙ УРОВЕНЬ КОТЕЛ 2

2840
2842



Segnale allarme a caldaia 3
МИНИМАЛЬНЫЙ УРОВЕНЬ КОТЕЛ 3

2850
2852



Cumulativo allarmi
СОВОКУПНОСТЬ СИГНАЛОВ ТРЕВОГИ

				DATA	04/15
				DISEGN.	LB
00	First edition	04/15	LB	VISTO	AP
REV.	MODIFICA	DATA	FIRMA	APPR.	AP



ICI CALDAIE SpA
Campagnola di Zevio
Verona ITALY

FILE : QDEG21-1

DEG P
ICI CALDAIE Spa

Lista morsetti
ПЕРЕЧЕНЬ КЛЕММНЫХ КОРОБОК

QDEG21-1

=	
+	
-	
FG.	30
F.S.	-